



3/2-way Solenoid Valve, direct-acting, NC or NO

- Electrical connection cable plug, Form A
- With or without manual override as standard
- Threaded port and sub-base versions
- Impulse version optional

Type 6014 can be combined with...



Type 2508

Cable Plug



Type 1078

Timer unit



Type 6014

Multiple manifold
(e.g. 6-fold)



Type 2511

ASI cable plug

This direct-acting 3/2-way solenoid valve may be mounted singly or in flange version on a manifold. FKM high quality seal material can be used for a lot of different mediums. The valve is also suitable for technical vacuum.

Circuit function C

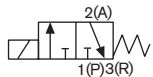

3/2-way valve NC,
outlet 2 relieved

Circuit function D

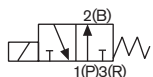

3/2-way valve NO, outlet
2 normally pressurized

Circuit function T

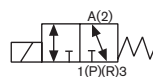

3/2-way,
universal valve

Technical data

Body material	Brass or stainless steel, polyamide (sub-base)
Seal material	FKM (EPDM on request)
Medium	Neutral gases and fluids (e.g. compressed air, town gas, natural gas, water, hydraulic oil, petrol). Suitable for technical vacuum
Medium temperature Polyamide coil (FKM seal)	-10° to +100°C (PA coil) to 120°C Epoxy coil
Ambient temperature	-10 to +55°C
Viscosity	Max. 21 mm ² /s
Port connection	G 1/8, G 1/4, sub-base
Operating voltage	24 V DC, 24 V/50 Hz, 230 V/50 Hz (other voltages on request)
Voltage tolerance	±10%
Duty cycle / single valve Assembly	100% continuous rating Intermittent operation 60% (30 min) or with 5 W coil (on request)
Electrical connection According to	DIN EN 175301-803 Form A for Cable Plug, Type 2508 (see Ordering chart for accessories)
Installation	As required, preferably with actuator upright
Protection class	IP65 with Cable Plug
Coil insulation class	Polyamide class B (Epoxy class H on request)
Coil material	Polyamide (Epoxy on request)
Orifice	DN 1.5- 2.5

Technical data

Power consumption

Orifice [mm] [mm]	Power consumption			DC hot / cold coil [W]
	Inrush AC [VA]	Hold AC (hot coil) [VA]	[W]	
1.5-2.5	24	17	8	8 / 9

Response times

Orifice [mm]	Response times AC and DC	
	Opening [ms]	Closing [ms]
1.5	10-15	15-20
2.0	10-15	15-20
2.5	15-20	10-22

Response times [ms]:

Measured at valve outlet at 6 bar and +20°C.
Opening: Pressure build-up 0 - 90%, to

Closing: Pressure relief 100 to 10%

Utilisation in another circuit function

Valves with circuit functions (WW) C, D and T are fitted with different springs. If used in some other circuit function, the permissible operating pressure may change (see table below).

Valve Version Basic version		Max. operating pressure [bar] for valve application in circuit function				
DN	Circuit function	A	B	C	D	T
1.5	C	16	22	16	2	2
	D	2	2.5	2	16	2
	T	10	16	10	6	6
2.0	C	10	14	10	1	1
	D	1	1.5	1	10	1
	T	6	10	6	4	4
2.5	C	6	9	6	0.7	0.7
	D	0.7	1	0.7	6	0.7
	T	3.5	6	3.5	2.5	2.5

Connections

For the positions marked with *, ** or *** in the drawing, the connections are marked with the letters shown in the table above, depending on the circuit function. Unused connections in circuit functions A or B will be closed off with a blanking plug or cap nut.

Circuit function	Connection Type		
	*	**	***
A	P	blank off	A
B	blank off	B	P
C	P	R	A
D	R	P	B
T	P	R	A

Materials

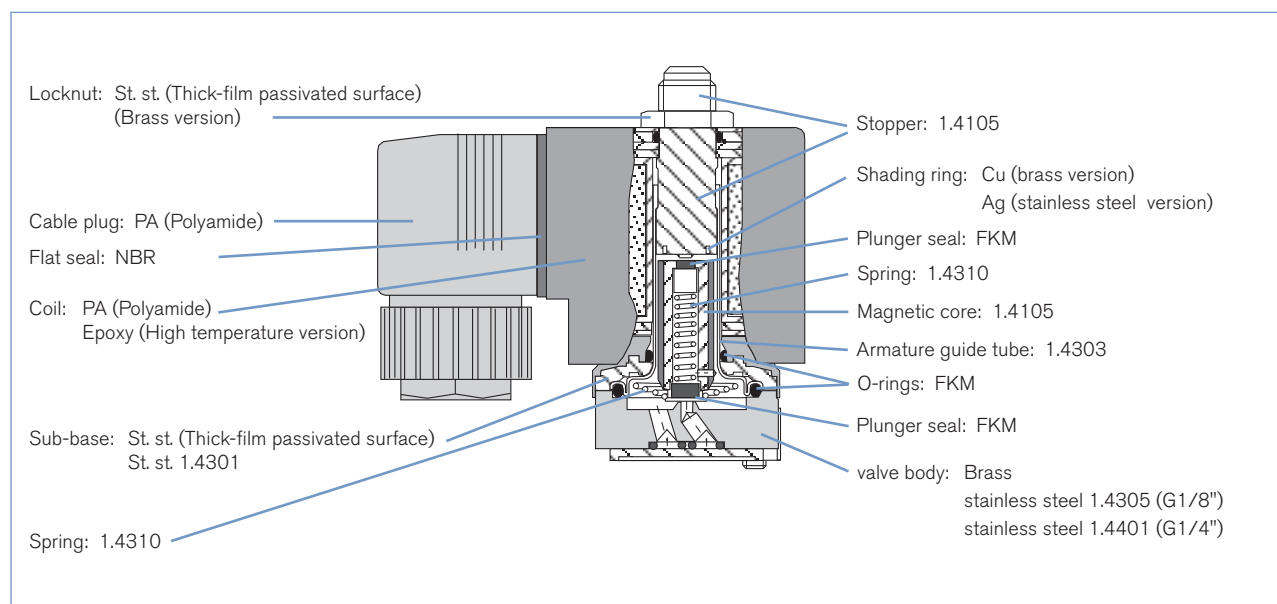

Ordering chart for valves (other versions on request)

Valves with threaded port

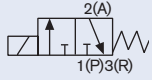
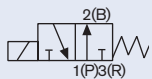
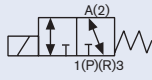
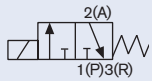
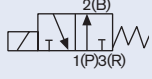
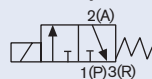
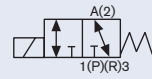

Circuit function	Orifice [mm]	Port connection	Kv value water [m ³ /h ¹⁾	Pressure range [bar ²⁾	Effective coil power [W]	Item no. per voltage / frequency		
						024/DC	024/50	230/50
Brass body								
without manual override								
C 3/2-way valve NC 	1.5	G 1/8	0.07	0 - 16	8	125 329	125 331	125 332
	2.0	G 1/8	0.11	0 - 10	8	125 333	125 334	125 336
		G 1/4	0.11	0 - 10	8	125 348	126 138	126 140
	2.5	G [mm] 1/8	0.16	0 - 6	8	125 341	125 340	125 342
		G 1/4	0.16	0 - 6	8	126 142	126 143	126 145
D 3/2 way valve, NO 	1.5	G 1/8	0.07	0 - 16	8	126 195	126 196	125 355
	2.0	G 1/8	0.11	0 - 10	8	125 357	125 358	125 360
		G 1/4	0.11	0 - 10	8	126 198	126 199	126 201
	2.5	G 1/8	0.16	0 - 6	8	125 363	126 202	126 204
		G 1/4	0.16	0 - 6	8	126 205	126 206	126 208
T 3/2-way Universal valve 	1.5	G 1/8	0.07	0 - 7	8	126 150	126 151	126 153
with manual override								
C 3/2-way valve NC 	2.0	G 1/8	0.11	0 - 10	8	125 337	125 338	125 339
		G 1/4	0.11	0 - 10	8	125 349	126 147	126 149
D 3/2 way valve, NO 	2.0	G 1/8	0.11	0 - 10	8	126 209	125 361	126 211
		G 1/4	0.11	0 - 10	8	126 212	126 213	126 215
Stainless steel body								
C 3/2-way valve NC 	1.5	G 1/8	0.07	0 - 16	8	126 216	126 217	126 219
	2.0	G 1/8	0.11	0 - 10	8	126 220	126 221	126 223
		G 1/4	0.11	0 - 10	8	126 224	126 225	126 227
T 3/2-way, universal valve 	1.5	G 1/8	0.07	0 - 7	8	126 228	126 229	126 231

¹⁾ Measured at +20 °C, 1 bar²⁾ pressure difference²⁾ Measured as overpressure to the atmospheric pressure

Please note that the cable plug has to be ordered separately, see accessories on page 6 and separate datasheet for Type 2508.

Ordering chart for valves (other versions on request)

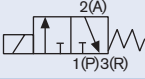
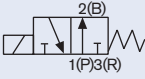
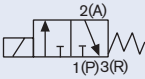
Valves with sub-base body without cable plug

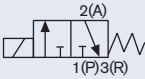
Circuit function	Orifice [mm]	Kv value water [m ³ /h] ¹⁾	Pressure range [bar] ²⁾	Effective coil power [W]	Item no. per voltage / frequency		
					024/DC	024/50	230/50
Brass body							
without manual override							
C 3/2-way valve NC 	1.5	0.07	0 - 16	8	126 154	126 155	125 366
	2.0	0.11	0 - 10	8	125 367	125 368	125 370
D 3/2 way valve, NO 	2.0	0.11	0 - 10	8	126 161	126 162	125 383
with manual override							
C 3/2-way valve NC 	1.5	0.07	0 - 10	5	126 403	126 404	126 406
	1.5	0.07	0 - 16	8	126 157	126 158	126 160
	2.0	0.11	0 - 6	5	126 407	126 408	126 410
	2.0	0.11	0 - 10	8	125 371	125 372	125 374
Polyamide body material							
without manual override							
C 3/2-way valve NC 	1.5	0.07	0 - 10	5	126 390	126 391	126 393
with manual override							
C 3/2-way valve NC 	1.5	0.07	0 - 10	5	126 396	126 397	126 399

¹⁾ Measured at +20 °C, 1 bar ²⁾ pressure difference

²⁾ Measured as overpressure to the atmospheric pressure

Please note that the cable plug has to be ordered separately, see accessories on page 6 and separate datasheet for Type 2508.

Ordering chart for valves, impulse version (other versions on request)

All valves with AC10-coil (32 mm), impulse Version, seal material FKM, thermic insulation class H (epoxy coil), medium temperature -10° up to +120°C, without manual override and Cable Plug

Circuit function	Port connection	Orifice [mm]	Kv value water [m ³ /h] ¹⁾	Pressure range [bar] ²⁾	Power consumption DC (hot/cold coil) [W]	Item no. per voltage/frequency [V/Hz]		
						012/DC	024/DC	
C 3/2-way valve, output 2 exhausted 	Brass body							
	Threaded port	G 1/8	1.5	0.07	0-16	7	209 280	209 284
			2.0	0.11	0-10	7	209 281	209 285
	Sub-base	sub-base	1.5	0.07	0-16	7	209 278	209 282
2.0			0.11	0-10	7	209 279	209 283	

¹⁾ Measured at +20 °C, 1 bar²⁾ pressure difference
²⁾ Measured as overpressure to the atmospheric pressure

Please note that the cable plug has to be ordered separately, see accessories on page 6 and separate datasheet for Type 2508.

Activation of the impulse version with inverse polarity operation

The polarity is labelled on the valve	Specifications	Terminal connections
- switch ON +	valve (P-seat) will be opened	(+) on terminal 2 and (-) on terminal 1 (see below)
+ switch OFF -	valve (P-seat) will be closes	(+) on terminal 1 and (-) on terminal 2 (see below)

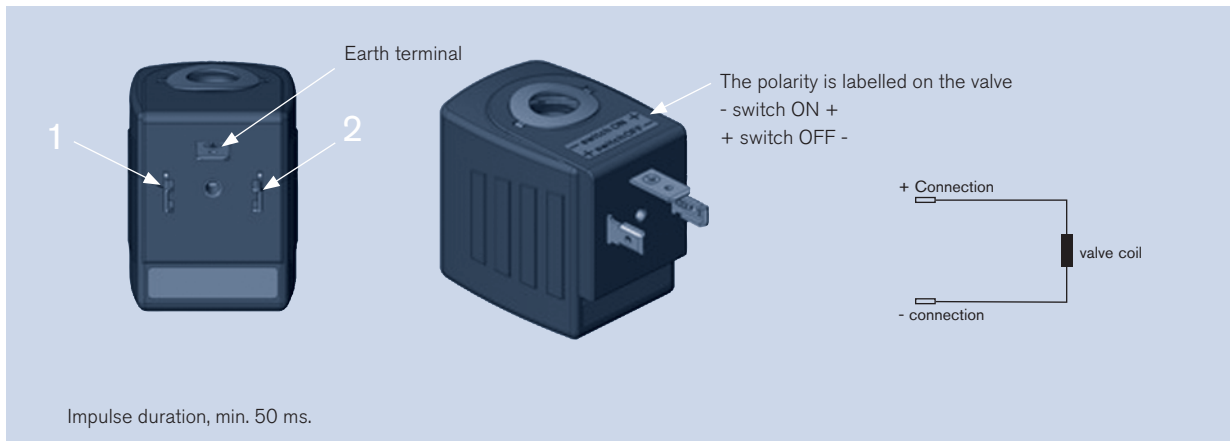

Note: Only cable plug without circuitry should be used together with impulse version!

i Further versions on request

Materials
 Epoxy coil according to Form A
 Seal material EPDM

Voltage
 Non-standard voltages

Port connection
 With banjo nut

Approvals
 ATEX, UL, CSA

Additional
 Orifice: 1.2mm, 3.0mm

Ordering chart for accessory

Cable plug Type 2508 according to DIN EN 175301-803 Form A

	Circuitry	Voltage/ Frequency	Item no.
	None (standard)	0 - 250 V AC/DC	008 376
	with LED	12 - 24 V AC/DC	008 360
	with LED and varistor	12 - 24 V AC/DC	008 367
	with LED and varistor	200- 240V	008 369
	with inverter ¹⁾	24V DC	on request
	further versions see datasheet Type 2508		

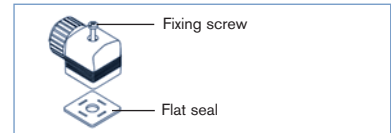

The delivery of a cable plug includes the flat seal and the fixing screw. For other cable plug versions acc. to DIN EN 175301-803 Form A (previously DIN 43650), see separate datasheet Type 2508. Click on the box "More info." and you will come to our website for this product where you can download the datasheet.

More info.

¹⁾ The inverter plug includes an electronic which is specially adapted for an electrical control with 3 wires Input 3 wire technology, common "-" polarity, two split "+" polarity. Output suitable for impulse model for Type 6013/6014

Ordering chart for Manifolds

Accessory parts	Features				Item no.
Single manifold	in aluminium black anodized				005 020
Multiple manifold	in aluminium	Hole spacing A [mm]	Total length B [mm]	Hole spacing C [mm]	
	2 valves	57	65	–	005 023
	3 valves	90	98	–	005 286
	4 valves	123	131	–	005 287
	5 valves	156	164	57	005 035
	6 valves	189	197	57	005 038
	8 valves	255	263	90	005 386
10 valves	321	329	90	005 764	
Covering plate	with plugs and O-ring, for closing off unused valve positions				005 630

Manifolds in Brass or stainless steel on request

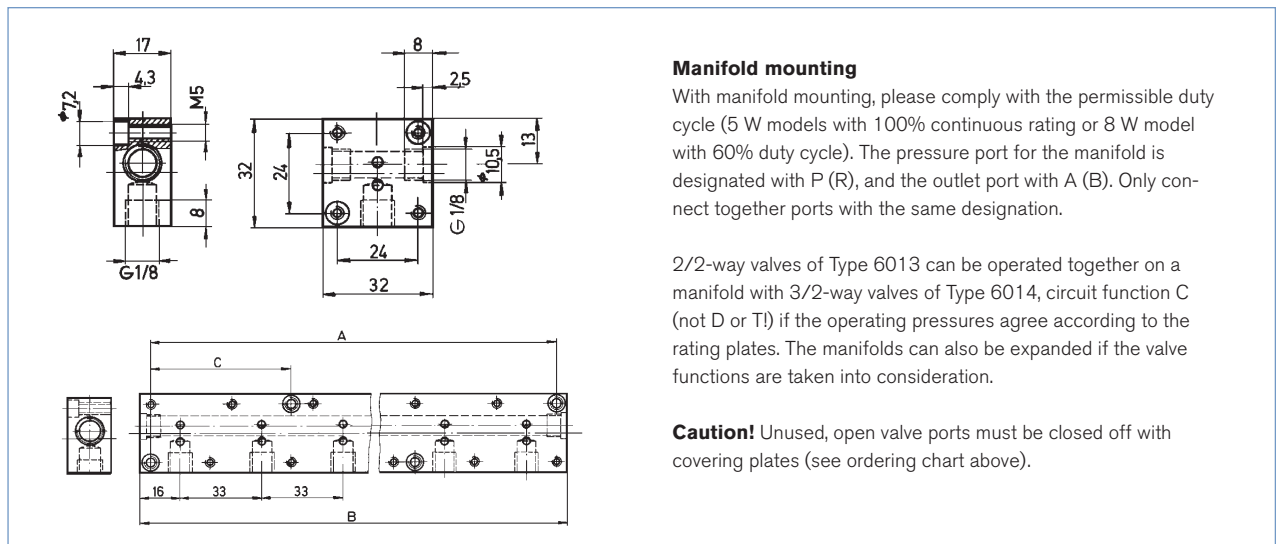

Dimensions [mm]

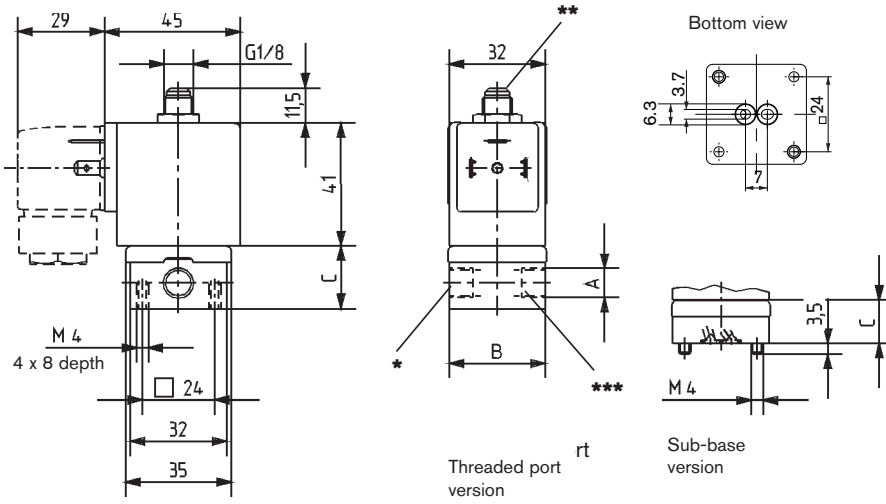

Dimensions [mm]			
version	A	B	C
Threaded port without manual override	G 1/8	32	20.8
	G 1/4	46	26.8
Threaded port with manual override	G 1/8	32	20.8
	G 1/4	46	26.8
Sub-base	-	32	14.3

DTS 1000011035 EN Version: F Status: RL (released | freigegeben | valide) printed: 10.08.2009

To find your nearest Bürkert facility, click on the orange box → www.burkert.com

In case of special application conditions, please consult for advice.

Subject to alterations
© Christian Bürkert GmbH & Co. KG

0908/4_EU-en_00895091